

**800 XL™
COMPUTER
FIELD SERVICE
MANUAL**

ATARI®

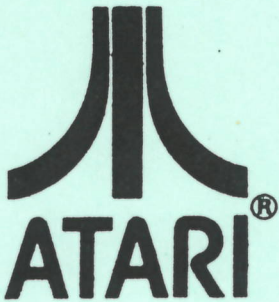

ATARI (U.S.) CORP.

FD100740

REV. 02

JUNE 1985

ATARI
800XL™ COMPUTER
FIELD SERVICE MANUAL

Atari believes that the information described in this manual is accurate and reliable, and much care has been taken in its preparation. However, no responsibility, financial or otherwise, shall be accepted for any consequences arising out of the use of this material. Information contained herein is subject to change. Revisions may be issued to advise of such changes and/or additions.

Correspondence regarding this document should be forwarded to Director of Technical Support, Consumer Product Service, Atari, Incorporated, 1272 Borregas Avenue, Sunnyvale, California 94086.

TABLE OF CONTENTS

<u>Section</u>	<u>Title</u>	<u>Page</u>
	INTRODUCTION	v
1	THEORY OF OPERATION	1-1
	User Interface	1-1
	Mechanical Theory	1-2
	Electrical Theory	1-4
	6502C CPU Microprocessor	1-4
	Alphanumeric Television	
	Interface Controller (ANTIC)	1-5
	Graphic Television	1-6
	Interface Adaptor (GTIA)	
	Pot Keyboard Integrated Circuit (POKEY)	1-7
	Peripheral Interface Adaptor (PIA)	1-8
	Memory (ROMs and DRAMs)	1-9
	OS ROM	1-9
	BASIC ROM	1-9
	DRAMs	1-9
	Memory Management Unit (MMU)	1-9
	RF Modulator	1-10
	Monitor Output	1-10
	Power Supply	1-10
	System Interface	1-11
	Serial Input/Output (SIO) Interface	1-11
	Keyboard Interface	1-12
	Controller Jack Interfaces	1-13
	Cartridge Interface	1-13
	Parallel Bus Interface	1-15
2	TESTING	2-1
	Overview	2-1
	Equipment Needed	2-1
	Self Test Features	2-1
	Description of Self Tests	2-2
	Memory Test	2-2
	Audio Visual Test	2-2
	Keyboard Test	2-2
	All Tests	2-3
	SuperSALT Testing	2-3
3	SYMPTOM CHECKLIST	3-1
4	ASSEMBLY/DISASSEMBLY	4-1
5	SCHEMATICS AND SILKSCREENS, AND PARTS LIST	5-1
	Parts List	5-3
6	SERVICE BULLETINS	6-1

TABLE OF CONTENTS

LIST OF ILLUSTRATIONS

<u>Figure</u>	<u>Title</u>	<u>Page</u>
1-1	System Block Diagram	1-2
1-2	Functional Block Diagram	1-3
1-3	6502C CPU Pin Assignments	1-5
1-4	ANTIC Display Processor Pin Assignments	1-6
1-5	GTIA Pin Assignments	1-7
1-6	POKEY Pin Assignments	1-8
1-7	PIA Pin Assignments	1-9
1-8	Power Supply Pin Assignments	1-10
1-9	SIO Connector Pin Assignments	1-12
1-10	Controller Jack Pin Assignments	1-13
1-11	Cartridge Connector Pin Assignments	1-14
1-12	PBI Connector Pin Assignments	1-15

INTRODUCTION

The Atari 800XL™ Computer Field Service Manual is a reference guide for the service technician.

The Field Service Manual is organized into six sections:

- o **THEORY OF OPERATION** - Overview of how the 800XL works and what its basic assemblies look like.
- o **TESTING** - Review of Diagnostic tests available for diagnosing 800XL problems.
- o **SYMPTOM CHECKLIST** - Failure information to aid the technician for a rapid diagnosis of 800XL problems.
- o **ASSEMBLY/DISASSEMBLY** - Assembly/Disassembly instructions.
- o **SCHEMATICS AND SILKSCREENS, AND PARTS LIST** - Electrical drawings and layouts of the 800XL Printer Circuit Board and a list of the parts used.
- o **SERVICE BULLETINS** - Section to be used for Field Change Orders, Upgrade Bulletins and Tech Tips.

SECTION 1

THEORY OF OPERATION

The Atari 800XL™ is an enhanced version of the existing ATARI Computer Systems. It can be used with any of the existing Atari peripheral devices used with the 400™/600XL™/800™/1200XL™ Computers.

The PCB contains 64K of RAM, an operating system that contains one 16K X 8 ROM and an on-board Atari BASIC programming language I.C. The console contains the keyboard and four function keys (including a HELP key), plus a RESET key, a single cartridge slot, connector jack for daisy-chaining peripherals and connecting hand controllers, a detachable (RF) TV interface cable, a 5 pin DIN Monitor Jack, one status LED (POWER), and a parallel bus interface (PBI).

USER INTERFACE

The Atari 800XL is a general purpose microcomputer that uses a 6502C microprocessor. The 800XL console is the central processing unit for its respective system.

The right side panel contains the controller jacks that accept the Atari X-Y joysticks and paddle controllers.

The rear panel contains the serial input/output (SIO) jack, the PBI, the RF jack, the monitor jack, the channel 2-3 switch, the power in jack, and the power switch (On/Off).

The console has a 3/4 stroke, 56 key, alphanumeric keyboard, that includes special characters and controls, space bar, four function keys, HELP key, and power indicator. The function and HELP keys are discussed below.

FUNCTION KEYS

RESET - Interrupts and restarts the operating system (OS) or cartridge. When pressed while the computer is ON, this key enables the BASIC.

START - Starts the game or program.

SELECT - Selects different program or game variations.

OPTION - Allows the player to choose variations of a program. If the OPTION Key is not depressed and held at the time the computer is turned ON, the built-in BASIC is automatically enabled. If the OPTION key is depressed and held at the same time the computer is turned ON, the on board BASIC is disabled and, when there is no cartridge or diskette in the system, the Self-Test menu appears.

HELP - Returns to main self-test menu from individual test and for future software development for user "help" functions. If you are familiar with 1200XL operation, this key does not function the same.

MECHANICAL THEORY

The 800XL computer console contains a single motherboard which houses all the chips of the system and provides connectors for interfacing external modules to the console. It includes the CPU, RAM, OS and BASIC ROM's. The motherboard uses a common address bus, data bus and clock lines. The sixteen-line address bus allows the microprocessor to directly address 64K memory locations. The eight-line data bus provides the communication and data path between the functional modules. The power is provided by an external power supply and routed throughout the console.

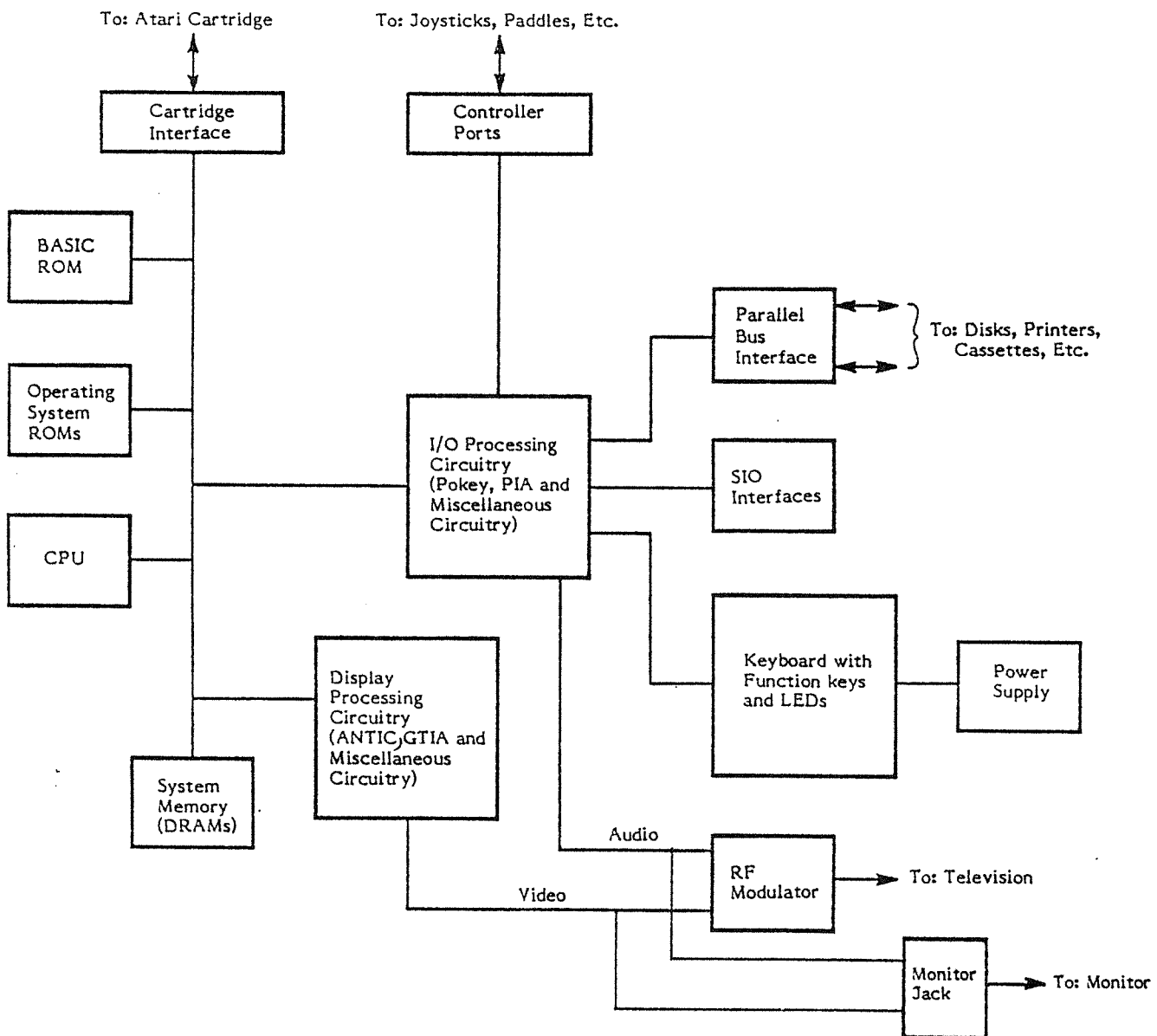

Figure 1-1. System Block Diagram
1-2

The keyboard connects to the PC Board by a 24-connector ribbon cable.

The keyboard is the user interface with the computer.

All peripherals connect to the 800XL either through the SIO connector or the PBI. Power enters through the 7-Pin DIN connector on the rear panel. RF to the TV switchbox arrives from an RCA phono connector and RF cable. Composite Video composite luminance, and audio signals to the monitor arrive from a 5 pin DIN monitor jack on the rear panel. Power On/Off is controlled by the ON/OFF switch on the rear panel.

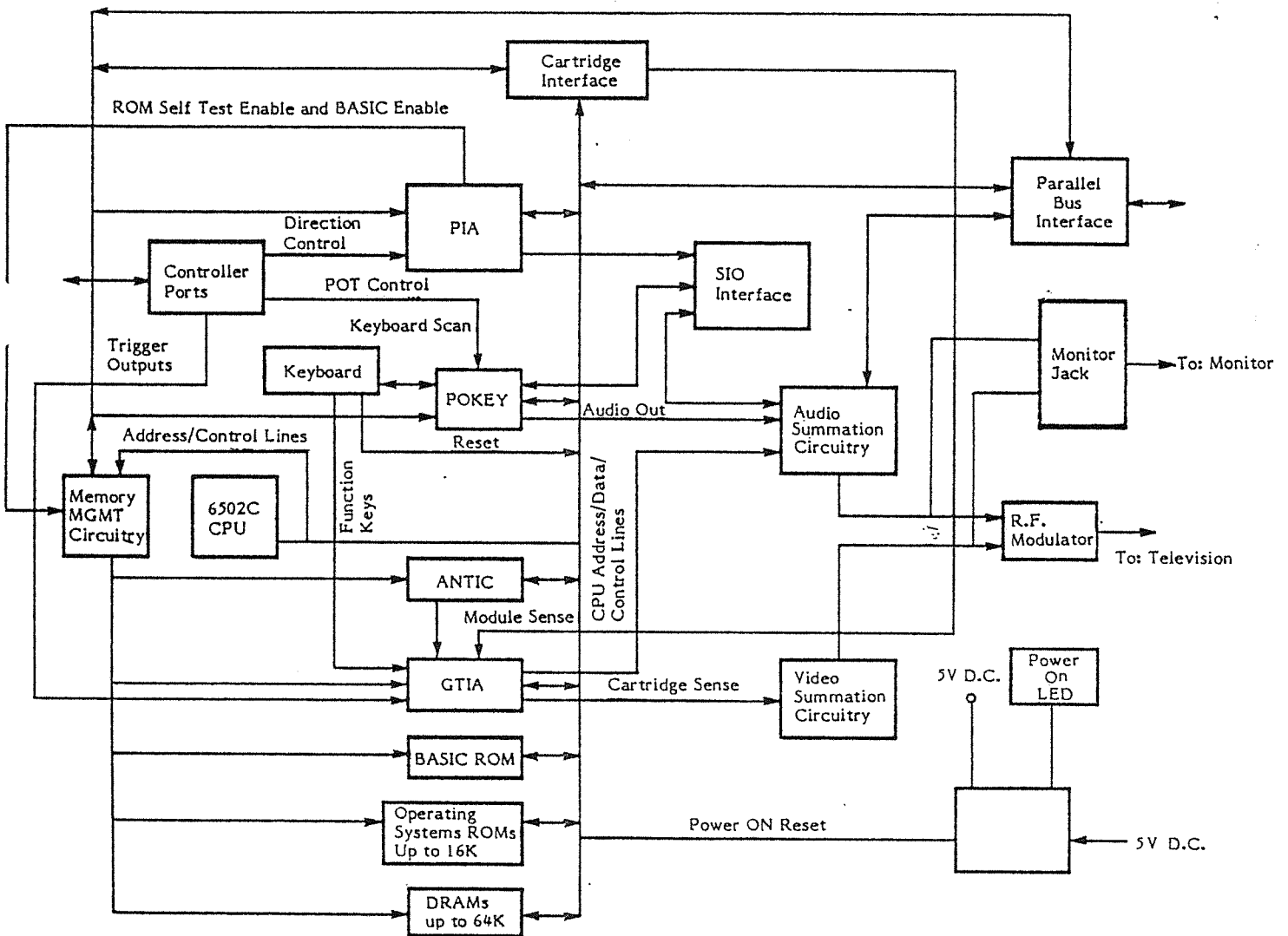

Figure 1-2. Functional Block Diagram

ELECTRICAL THEORY

DIGITAL HARDWARE

The digital hardware consists of:

- o The 6502C CPU microprocessor
- o The Alphanumeric Television Interface Controller (ANTIC)
- o The Graphics Television Interface Adaptor (GTIA)
- o The POT KEYboard Integrated Circuit (POKEY)
- o The Peripheral Interface Adaptor (PIA)
- o The Memory (O.S. ROM, 64K RAM, Atari BASIC ROM, Rev. B)
- o Miscellaneous Logic
 - Memory Management Unit (MMU)
 - Delay Line
- o Parallel Bus Interface (PBI)

6502C CPU Microprocessor

The 6502C CPU microprocessor contains register flags, interconnections, arithmetic logic, control logic, and all recognized operation codes. The characteristics of the microprocessor include:

- o Byte-oriented structure
- o 151 opcodes
- o Decimal and binary arithmetic modes
- o Seven addressing modes
- o True indexing
- o Stack pointer
- o Two interrupt levels
- o 64K address range
- o Integral clock circuit
- o Single +5 volt DC power requirement

Figure 1-3 is an illustration of the 6502C CPU Pin Assignments.

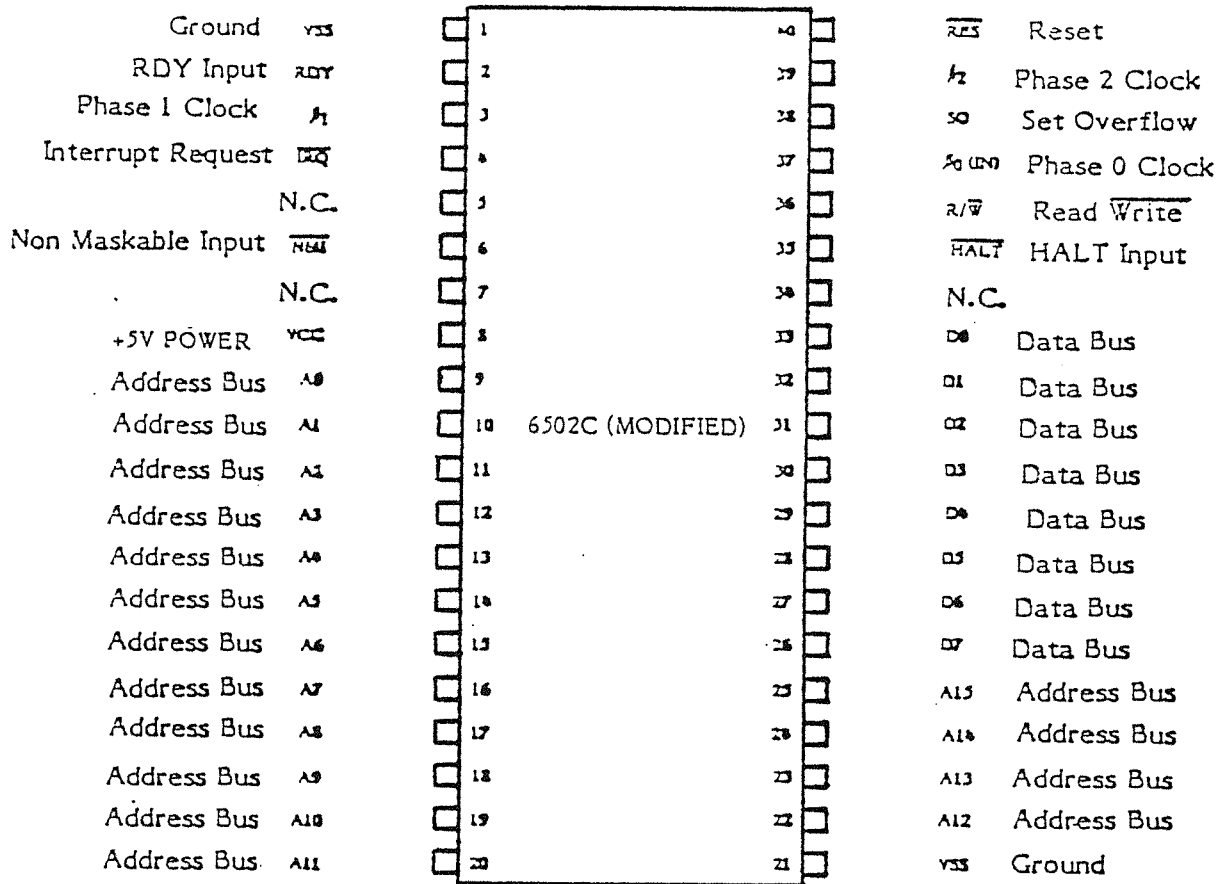

Figure 1-3. 6502C CPU Pin Assignments

Alphanumeric Television Interface Controller (ANTIC)

The ANTIC Display Processor is a custom display microprocessor with an instruction set customized for graphics generation. It also has the ability to control the ADDRESS & DATA bus and RAM Refresh.

Figure 1-4 is an illustration of the ANTIC Display Processor pin assignments.

GROUND	VSS	1	ANTIC	40	D4	Data Bus
Alphanum. Data	AN0	2		39	D5	Data Bus
Alphanum. Data	AN1	3		38	D6	Data Bus
Light Pen	LP	4		37	D7	Data Bus
Alphanum. Data	AN2	5		36	RST	Reset
(SYS RST)	RNMI	6		35	F00	Fast Phase 0 Clock
Interrupt Output	NMI	7		34	00	Phase 0 Clock
Refresh	REF	8		33	D3	Data Bus
HALT	HALT	9		32	D2	Data Bus
Address Bus	A3	10		31	D1	Data Bus
Address Bus	A2	11		30	D0	Data Bus
Address Bus	A1	12		29	02	Phase 2 Clock
Address Bus	A0	13		28	A4	Address Bus
Read/Write	R/W	14		27	A5	Address Bus
Ready Output	RDY	15		26	A6	Address Bus
Address Bus	A10	16		25	A7	Address Bus
Address Bus	A12	17		24	A8	Address Bus
Address Bus	A13	18		23	A9	Address Bus
Address Bus	A14	19		22	A11	Address Bus
Address Bus	A15	20		21	VCC	5V Power

Figure 1-4. ANTIC Display Processor Pin Assignments

Graphic Television Interface Adaptor (GTIA)

The GTIA interfaces with the ANTIC processor on one side and with the video summation circuitry on the other. Its primary task is to generate color and luminance signals from the bit stream it receives from the ANTIC Display Processor. It also processes the Function keys, provides the keyboard "beep" via the TV speaker and monitors controller Trigger lines.

Figure 1-5 is an illustration of the GTIA pin assignments.

Address Bus	A1	1		40	A2	Address Bus
Address Bus	A0	2		39	A3	Address Bus
Ground	VSS	3		38	A4	Address Bus
Data Bus	D3	4		37	D4	Data Bus
Data Bus	D2	5		36	D5	Data Bus
Data Bus	D1	6		35	D6	Data Bus
Data Bus	D0	7		34	D7	Data Bus
Trigger 0	T0	8		33	R/W	Read/Write
Trigger 1	T1	9		32	CS	Chip Select 1
Trigger 2	T2	10		31	Lum 3	Luminance Line
Trigger 3	T3	11		30	Φ2	Phase 2 Input
Option	S0	12		29	F00	Clock Out
Start	S1	13		28	OSC	Oscillator Input
Select	S2	14		27	VCC	Power
Keyboard Click	S3	15		26	HALT	HALT
PAL Color Delay	PAL	16		25	CSYNC	Output Sync
Color Delay	CADJ	17		24	LUM 2	Luminance 2 Output
Alphanum. Data 0	AN0	18		23	LUM 1	Luminance 1 Output
Alphanum. Data 1	AN1	19		22	LUM 0	Luminance 0 Output
Alphanum. Data 2	AN2	20		21	COL	Color

Figure 1-5. GTIA Pin Assignments

POT KEYboard Integrated Circuit (POKEY)

The POKEY is a custom Large Scale Integrated circuit (LSI) chip. It is used for audio generation, Serial Input/Output (SIO) Data and Clocks, POT Controller interface scan, and keyboard scan.

Figure 1-6 is an illustration of the POKEY pin assignments.

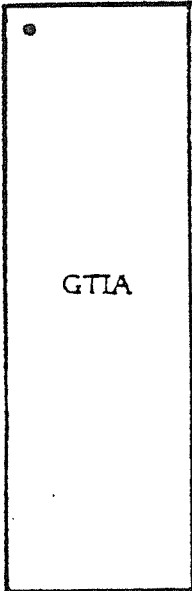
Ground	VSS	1		40	D2	Data Bus
Data Bus	D3	2		39	D1	Data Bus
Data Bus	D4	3		38	D0	Data Bus
Data Bus	D5	4		37	AUDIO	Audio Out
Data Bus	D6	5		36	A0	Address Bus
Data Bus	D7	6		35	A1	Address Bus
Phase 2 Clock	Ø2	7		34	A2	Address Bus
Pot Scan	P6	8		33	A3	Address Bus
Pot Scan	P7	9		32	R/W	Read/Write
Pot Scan	P4	10		31	CS1	Chip Select
Pot Scan	P5	11		30	CS0	Chip Select
Pot Scan	P2	12		29	IRQ	Interrupt Request
Pot Scan	P3	13		28	SOD	Serial Output Data
Pot Scan	P0	14		27	ACLK	Serial Output Clock
Pot Scan	P1	15		26	BCLK	Bidirectional Clock
Keyboard Response	KR2	16		25	KRI	Keyboard Response
5 V Power	VCC	17		24	SID	Serial Input Data
Keyboard Scan	K3	18		23	K0	Keyboard Scan
Keyboard Scan	K4	19		22	K1	Keyboard Scan
Keyboard Scan	K3	20		21	K2	Keyboard Scan

Figure 1-6. POKEY pin assignments

Peripheral Interface Adaptor (PIA)

The PIA is a general purpose Input/Output (I/O) chip. It monitors the X-Y controller interfaces and the SIO control lines. In certain applications it may control the MMU logic.

Figure 1-7 is an illustration of the PIA assignments.

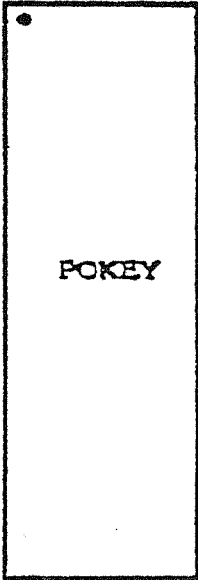
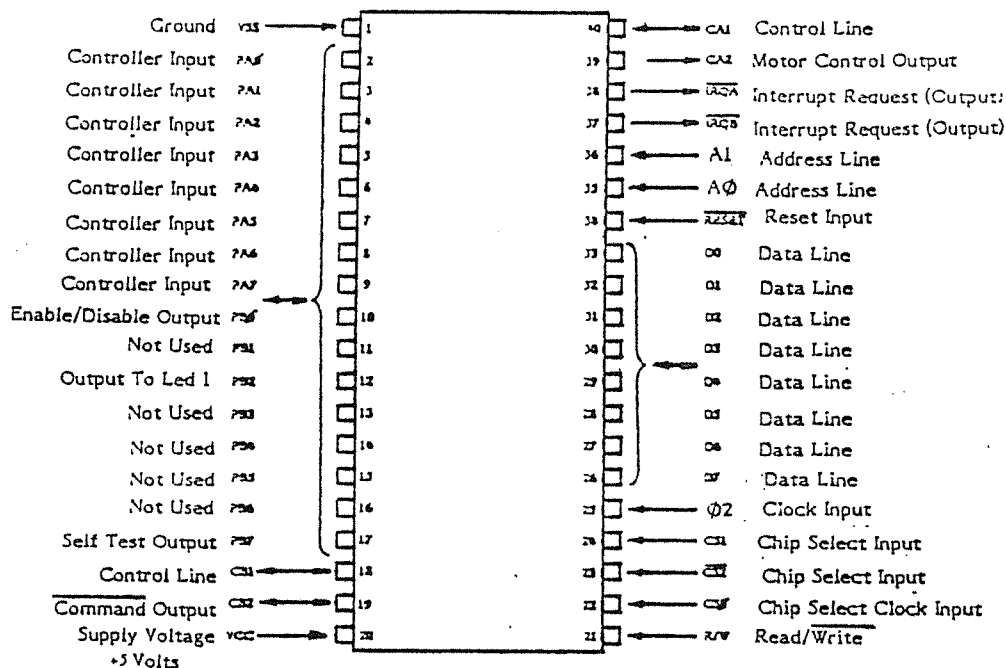

Figure 1-7. PIA Pin Assignments

MEMORY (ROMS AND DRAMS)

O.S. ROM

The 800XL operating system is resident in one 16K X 8 ROM. The ROM address inputs are from CPU address lines A0 through A13. The chip selects from the address decoding circuitry and generates data on CPU data lines D0 through D7. The ROM requires a power input of +5 volts.

BASIC ROM

The Atari 800XL has built-in Atari BASIC (Rev. B) residing in an 8K X 8 ROM. This is equivalent to having an Atari BASIC cartridge permanently plugged into the console. Any cartridge plugged into the computer, takes precedence over the built-in BASIC.

DRAMS

The 800XL Dynamic Random Access Memories (DRAMS) consist of eight 64K X 1 DRAMS.

MEMORY MANAGEMENT UNIT (MMU)

The memory management unit (MMU) address decoding circuitry consists of a PLA (Programmable Logic Array) I.C., one 3 to 8 decoder and a few gates. The input to the circuitry includes the address lines A8 through A15 as well as control signals, such as ROM enable (from PIA) and DRAM refresh from ANTIC. Some of the most important outputs of this circuitry include select signals for the GTIA, POKEY, PIA, OS ROM, DRAMS, BASIC and cartridge.

RF MODULATOR

The RF modulator accepts the composite video from the video summation circuitry and the mono-aural audio signals and produces a modulated signal suitable for the television.

With a 75 Ohm termination, the modulated signal has the following characteristics:

Maximum Voltage: 2MV
Minimum Voltage: 1MV

Audio Sound Carrier Frequency: 4.5 MHz

Frequency Response:

Channel 2 -

Band: 6 MHz

Video Carrier: 55.25 MHz

Audio Carrier: 59.75 MHz

Channel 3 -

Band: 6 MHz

Video Carrier: 61.25 MHz

Audio Carrier: 65.75 MHz

MONITOR OUTPUT

The 5 pin DIN monitor output jack (J2) accepts the composite video and the composite luminance signals from the GTIA video summation circuitry and the amplified mono-aural audio signals from POKEY. J2 then transfers these signals directly to the input of the video monitor via a 5 pin DIN monitor cable.

The output signals have the following characteristics:

	<u>Min. Voltage</u>	<u>Max. Voltage</u>
Composite Video	750 MV P-P	1V P-P
Composite Luminance	1.2V P-P	1.5V P-P
Audio	600 Mv P-P	750 Mv P-P

POWER SUPPLY

The power supply connector is a 7-pin DIN connector.

The Atari 800XL has an external power supply that accepts 110 VAC (nominal) from the power lines and provides +5 VDC output (+/- 2%). The maximum rating for the supply is + 5 volts and 1.2 amps.

Figure 1-8 is an illustration of the power supply connector pin assignments.

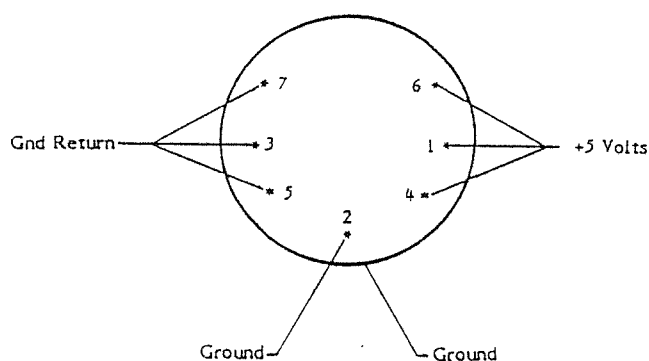

Figure 1-8. Power Supply Pin Assignments
(Looking Toward Computer)

SYSTEM INTERFACE

The 800XL provides the following interfaces:

- o Serial input/output (SIO)
- o Keyboard Interface
- o Controller Jacks
- o Cartridge Interface
- o Parallel Bus Interface (PBI)

SERIAL INPUT/OUTPUT (SIO) INTERFACE

The Atari 800XL communicates with peripheral devices via an asynchronous serial port (19.2K Baud rate max.). Data is transmitted and received as eight bits of serial data. LSB is sent first preceded by a logic zero start bit and succeeded by a logic one stop bit. The serial data out is transmitted or received as positive logic. The serial data out line always assumes its new state when the serial clock out line goes high. Clock out goes low in the center of data out.

The bus protocol specifies that all commands must originate from the computer and that peripherals present data on the bus only when commanded to do so. Every bus operation goes to completion before another bus operation is initiated. An error detected at any point in the bus operation aborts the entire sequence. A bus operation consists of the following elements:

- Command Frame (From Computer)
- Command Frame
 - 1) Data Send
 - 2) Data Receive
 - 3) Immediate (No Data-Command Only, i.e., status)
- Acknowledge Frame (From Peripheral)
- Optional Data Frame (To Or From Computer)
- Complete Frame (From Peripheral)

Figure 1-9 shows pin assignments for the SIO connector.

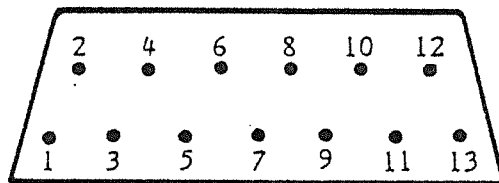

- | | |
|-----------------|-------------------|
| 1. Clock Input | 8. Motor Control |
| 2. Clock Output | 9. Proceed |
| 3. Data Input | 10. +5/Ready |
| 4. Ground | 11. Audio Input |
| 5. Data Output | 12. Not Connected |
| 6. Ground | 13. Interrupt |
| 7. Command | |

Figure 1-9. SIO Connector Pin Assignments

KEYBOARD INTERFACE

The keyboard has 55 alphanumeric keys (including special characters and controls), a spacebar, which interface thru U24 and U25 Keyboard Sense/Scan Decoders, four function keys, and a RESET key.

CONTROLLER JACK INTERFACES

The 800XL provides two controller jack interfaces. Both are functionally and electrically identical. The controller jacks are 9-pin D-type male connectors.

Figure 1-10 shows the pin assignments for the 9-pin connectors.

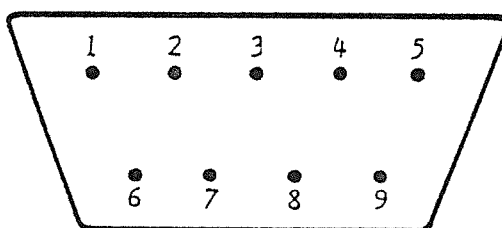

- | | |
|----------------------------|--------------------------|
| 1. (Joystick Forward Input | 6. Trigger Input |
| 2. (Joystick) Back Input | 7. +5 volts |
| 3. (Joystick) Left Input | 8. Ground |
| 4. (Joystick) Right Input | 9. A Potentiometer Input |
| 5. B Potentiometer, Input | |

Figure 1-10. Controller Jack Pin Assignments

CARTRIDGE INTERFACE

The cartridge interface connects cartridges to the computer with a 30-pin connector.

The Atari 800XL has Revision B of Atari BASIC built-in. This is equivalent to having a BASIC cartridge "permanently" plugged into the console. When any cartridge is plugged into the computer, it takes precedence over the built-in BASIC. This is a function of hardware. When no cartridge is plugged in, the hardware enables the built-in BASIC.

Figure 1-11 illustrates the pin assignments of the cartridge connector.

$\overline{S4}$	1	A	RD4		
A3	2	B	GND		
A2	3	C	A4		
A1	4	D	A5		
A0	5	E	A6		
D4	6	F	A7		
D5	7	H	A8		
D2	8	J	A9		
D1	9	K	A12		
CONSOLE BOTTOM	D0	10	L	D3	CONSOLE TOP
	D6	11	M	D7	
	$\overline{S5}$	12	N	A11	
	+5V	13	P	A10	
	RD5	14	R	R/ \overline{W}	
	\overline{CCNTL}	15	S	B0Z	

Figure 1-11. Cartridge Connector Pin Assignments

PARALLEL BUS INTERFACE

The parallel bus interface (PBI) provides an un-buffered, direct connection to the address, data and control signals shown below. It could be used to interface peripherals, parallel bus devices and external applications.

Figure 1-12 illustrates the pin assignments of the parallel bus interface.

Parallel Bus Specification

GROUND	GND	1	2	EXTSEL' (EXTERNAL SELECT)
(ADDRESS OUTPUT)	A0	3	4	A1 (ADDRESS OUTPUT)
(ADDRESS OUTPUT)	A2	5	6	A3 (ADDRESS OUTPUT)
(ADDRESS OUTPUT)	A4	7	8	A5 (ADDRESS OUTPUT)
(ADDRESS OUTPUT)	A6	9	10	GND
(ADDRESS OUTPUT)	A7	11	12	A8 (ADDRESS OUTPUT)
(ADDRESS OUTPUT)	A9	13	14	A10 (ADDRESS OUTPUT)
(ADDRESS OUTPUT)	A11	15	16	A12 (ADDRESS OUTPUT)
(ADDRESS OUTPUT)	A13	17	18	A14 (ADDRESS OUTPUT)
GROUND	GND	19	20	A15 (ADDRESS OUTPUT)
DATA BI-DIRECTIONAL	D0	21	22	D1 (DATA-BI-DIRECTIONAL)
DATA BI-DIRECTIONAL	D2	23	24	D3 (DATA-BI-DIRECTIONAL)
DATA BI-DIRECTIONAL	D4	25	26	D5 (DATA-BI-DIRECTIONAL)
DATA BI-DIRECTIONAL	D6	27	28	D7 (DATA-BI-DIRECTIONAL)
GROUND	GND	29	30	GND GROUND
PHASE 2 CLOCK-OUTPUT	B02	31	32	GND GROUND
N/C	RESERVED	33	34	RST' RESET OUTPUT
INTERRUPT REQUEST INPUT	IRQ	35	36	RDY READY INPUT
N/C	RESERVED	37	38	EXTENB EXTERNAL DECODER-OUTPUT
N/C	RESERVED	39	40	REF' REFRESH-OUTPUT
COLUMN ADDRESS-OUTPUT	CAS'	41	42	GND GROUND
MATH PACK DISABLE-INPUT	MPD'	43	44	RAS' ROW ADDRESS STROBE (OUTPUT)
GROUND	GND	45	46	LR/W' LATCHER READ/WRITE-OUTPUT
N/C	RESERVED	47	48	RESERVED N/C
AUDIO IN	AUDIO	49	50	GND GROUND

Figure 1-12. PBI Connector Pin Assignments
(Looking into the Computer)

SECTION 2

TESTING

OVERVIEW

This section describes the procedures available for testing and troubleshooting the 800XL. They are:

- o Self Test
- o SuperSALT Diagnostic Cartridge and SuperSALT Test Assembly

EQUIPMENT NEEDED

- o 800XL Computer console with accessories
- o TV set, properly adjusted
- o SuperSALT Diagnostic Cartridge (FD100335)
- o SuperSALT Test Assembly (FA100332)
- o SuperSALT Technical User's Manual (FD100770)

SELF TEST FEATURES

The Self Test feature allows minimal testing of the following components:

- o Memory - RAM, ROM and ANTIC
- o Audio/Visual - ANTIC, GTIA, and POKEY
- o Keyboard - POKEY and ANTIC

NOTE: Remove any cartridge from the unit.

To enter the testing sequence, press and hold the OPTION key while the console is turned on. The Self Test menu screen will appear.

To exit the test, press the SYSTEM RESET key; the Basic Ready prompt will appear on the screen.

NOTE: Pressing the HELP key has no effect in any situation, except possible future application programs and as an exit from individual test to return to Self Test menu.

Procedure:

1. Connect the computer console to TV set as shown in owner's manual.
2. Turn on TV set.
3. Press and hold the OPTION key as the computer is turned on until the Self Test menu appears.
4. The Self Test Menu displays four options:
 - o Memory
 - o Audio Visual
 - o Keyboard
 - o All Test

Press the SELECT key to move the selection indicator until you reach the desired test.

Press the START key to begin the test.

CAUTION: Self Test will not go into the Attract Mode. Do not leave Self Test screens on for any length of time (maximum seven minutes), since screen burning can occur.

DESCRIPTION OF SELF TESTS

MEMORY TEST

Purpose: To test the ROM, RAM, and ANTIC chips.

Format: Two long bars displayed at the top of the screen represent the 16K Operating System ROM. Below them are 48 blocks, each representing 1K of RAM. The remaining 16K of RAM is available only with certain software programs and is not tested at this time. When either ROM or RAM is being tested, the corresponding bar segment color is white. If the ROM or RAM tests good, the bar color changes to light green. If the ROM or RAM tests defective, the color changes to red. Once a ROM or RAM has been tested and found defective the bar or specific block remains red and the memory is not tested again on subsequent test passes.

The MEMORY TEST continues testing until either the HELP or RESET key is pressed.

NOTE: If RESET is used to exit a test, the OS will return to Basic not the Self Test. You must then press and hold OPTION and power up the console as before.

AUDIO VISUAL TEST

Purpose: To test the ANTIC and POKEY chips.

Format: The screen displays a music staff and treble clef. A sequence of six tones sound and the corresponding note shows on the staff. The tune plays sequentially from channel one through channel four. The channel number changes for each according to the sound channel in use. Voice numbers 1-4 under the staff and treble clef indicate the channel in use. There is a slight pause between each voice. A fault is indicated by a note appearing on the screen without any sound and vice versa.

The AUDIO VISUAL TEST continues testing until either the HELP or RESET key is pressed.

KEYBOARD TEST

Purpose: To test the POKEY, ANTIC and ROM chips

Format: A full keyboard is displayed on the screen. Press each keyboard key and the corresponding key on the screen changes to inverse video and a tone sounds. It should change back to the original color when the key is

released. NOTE: The control and shift keys change only when pressed at the same time as another key. The display for both keys will change to inverse video and then back. As each key (except RESET, HELP & BREAK) is pressed, a tone is generated.

ALL TESTS

All of the Self Tests are executed one after another until either the HELP or RESET key is pressed.

NOTE: When ALL TESTS is executing, the MEMORY TEST and the AUDIO VISUAL TEST exit after one complete test cycle. KEYBOARD TEST during ALL TESTS is software controlled. No operator input is required.

SUPERSALT TESTING

For SuperSALT testing procedures refer to SuperSALT Technical User's Manual (P/N FD100770).

SECTION 3
SYMPTOM CHECKLIST

The Symptom Checklist is designed to aid the technician in arriving at, listed in the order of failure, rapid diagnosis of problems. Each symptom is accompanied by some possible causes, and suggested remedies. **Instructions for disassembly/assembly, are in SECTION 4 of this manual.**

<u>SYMPTOM</u>	<u>POSSIBLE CAUSES</u>	<u>REMEDY</u>
Snowy Screen	TV Switch Box, ON/OFF switch, Channel Select switch, RF Modulator	Adjust or replace.
	Defective Power Supply, Damaged RF Cable	Replace
	Defective (open) components on +5C line.	Isolate and replace
	Defective (shorted) components on +5A, B and/or C lines.	Isolate and replace
Black/Grey Screen	Defective (shorted) LSI's and/or IC's	Isolate and repair
	Y1, Q8, 9, C109	Troubleshoot the clock circuit and replace defective component.
Red/Brown	U2, 7-20, 22, 23, 26-30	Isolate and replace defective IC
	U2-5, 18, 19, 28, 30	Isolate and replace defective IC
Blue screen	U2	Replace
Yellow screen	U28	Replace
No Color or Bad Color	RF Modulator or R38	Adjust or replace
	U17, U20, Q1, Q3, CR2, CR3	Troubleshoot color/video circuitry. Replace defective IC/component.
	Y1	Verify 3.579545 MHz freq. of Y1. Replace if defective

<u>SYMPTOM</u>	<u>POSSIBLE CAUSES</u>	<u>REMEDY</u>
No Power Light (L1)	Power LED, Power Supply, Cables	Repair or Replace.
No Gray Bars or Missing Bar	U17, U20	Repair or Replace.
Upside down Alpha/ Numerics on Player Field	U7	Replace.
Some Keyboard Keys Fail*	U22, Keyboard, U24, U25, Cable	Repair or Replace.
All Keyboard Keys Fail*	U22, 24, 25	Repair or Replace.
Tone or Tones Missing During Tone Test	U22, 4.5MHz, U1, Audio Carrier Frequency, TV volume	Repair, Adjust 4.5 MHz on RF Modulator. Replace if necessary.
Console Game Switches Will Not Functon	U17, Keyboard, Cable	Repair or Replace
ROM Test Failed	U2-U5	Repair or Replace.
RAM Test Failed	U2, 3, 9-16, 18, 19, 26-30	Verify ANTIC is <u>Rev E</u> . Repair or Replace.
Video or ANTIC Stress Fail	U7	Repair or Replace.
CPU Test Fail	Y1, Q8, Q9, U8	Verify 3.58 MHz osc. frequency. Repair or Replace.
2-Way Clock Fail**	J1, U22	Repair or Replace.
External Audio**	J1, U1	Repair or Replace.
GTIA Fail	U17	Replace.

* Keyboard and switch require operator intervention.

**Requires the SuperSALT Test Assembly, jumper cables, power supply for correct operation. Joystick and Paddle Test require user action with a joystick and paddle during respective testing.

<u>SYMPTOM</u>	<u>POSSIBLE CAUSES</u>	<u>REMEDY</u>
I/O Port Test Failures		
Voltage: P1, P2	L25, J5, J6	Inspect J5, 6 for damaged pins; replace as necessary
Voltage: MC	Q7, L11, U2	Repair or replace
PIA Ports	U23, C26-29, C82-92 L19-22	Repair or replace
SIO Port	U22, U23, C75-78	Repair or replace
Trigger Lines	U17, L23, L30, C96, C97	Repair or replace
POT Lines	U22, L15-18, C71-74 C63-66	Repair or replace
Timers	U22	Replace

SECTION 4

ASSEMBLY/DISASSEMBLY

Disassembly

Hardware Access

- o Turn unit upside down.
- o Remove six screws from bottom cover.
- o Turn unit upright.
- o Tip cover by raising the left side allowing access to the keyboard cable. Carefully disconnect the keyboard ground strap and remove the keyboard cable from its socket and lay top aside.

***** Due to incompatibility of plastic housings, do not interchange top or bottom housings between units. Keep the housings which belong to each unit with that unit.**

PCB Removal

- o Remove the four remaining screws holding the PC Board.
- o Lift up on the front of the PC Board while pushing out on the right side of the bottom housing (player port side) until the player ports clear the bottom housing.
- o Remove the PC Board.

Assembly

Reassemble in reverse order.

SECTION 5

SCHEMATICS AND SILKSCREENS AND PARTS LIST

The schematic and silkscreen for the 800XL are attached to the front cover of this manual. Remove them and place in this section.

NOTE: The schematic is a domestic/U.K. version. All U.K. additions are shown in dotted boxes. READ the notes at the bottom left corner before any troubleshooting is performed.

This section contains the complete Parts List for the 800XL.

SECTION 5

PARTS LIST

<u>Location</u>	<u>Description</u>	<u>Part Number</u>
	Console Assembly	
	Door, Cartridge	C024582-001
	Bar, Door	C024680-001
	Spring, Door	C024681-001
	Keyboard	C061983
	Power Supply	CA024814-001
	T.V. Switchbox (Pkgd)	CA014746
	RF Cable	CA024624-001
	PCB Assembly	
	Cartridge Guide	C060297
	Shield, Top	C024467-001
	Shield, Bottom	C024468-001
A1	Modulator, Domestic (UM1652)	C061619
C1	Cap. Elec. Axial 470uF (10V)	C014370
C2,3,10, 79	Cap. Elec. Axial 22uF (16V)	C014393
C4,7,11, 13,94,95	Cap. Ceramic Axial .01uF (25V)	C014181-02
C5,6,8,9, 12,14,15, 21,46,47, 54,71-78, 80-92,96, 97,102,112	Cap. Ceramic Axial .001uF (50V)	C014181-01
C16,18,25- 32,34-43, 48,51,57, 62,68-70, 93,105-109	Cap. Ceramic Axial .1uF (25V)	C014181-03
C17,23,63- 66	Cap. Ceramic Axial .047uF (50V)	C014180-09
C19,20,22	Cap Nonpolarized 4.7uF (35V)	C061647
C24,50,98	Cap. Elec. Alum 10uF (16V)	C014371
C44	Cap Ceramic Axial 68pF (50V)	C014179-12

PARTS LIST

<u>Location</u>	<u>Description</u>	<u>Part Number</u>
C45	Cap Ceramic Axial 220pF (50V)	C014180-05
C49	Cap Elec Axial 47uF (10V)	24-100476
C52,55	Cap Ceramic Axial 100pF (50V)	C014179-19
C53	Cap Ceramic Axial 3.9pF	C061336-01
CR1-5	Diode (1N4148)	C060607
J1	Connector, Rt. Angle (13 pin)	C012995
J2	Connector, Monitor (5 pin)	C014388
J4	Connector, Cartridge (30 pin)	C014389
J5,6	Connector, Rt. Angle (9 pin)	C010448
J7	Connector, DIN Power (7 pin)	C061838
J8	Connector, Keyboard Header (24 Pin)	C061793
L1-3,7,9, 11,12	Inductor Ferrite Bead	C014384
L4,5	Inductor Axial 820uH	C017948-03
L6	Inductor, Axial 100uH	C017948-04
L10,15-30	Inductor, Axial 10uH	C014381
L14	Inductor, Axial 22uH	C014380
Q1-5	Transistor, NPN (2N3904)	34-2N3904
Q7	Transistor, PNP (MPSA55)	C014809
Q8,9	Transistor, PNP (2N3906)	C018991
R1,11,59	Resistor, 1/4W 2.2K	14-5222
R2,7,52	Resistor, 1/4W 2K	14-5202
R3,58	Resistor, 1/4W 6.2K	14-5622
R4,39	Resistor, 1/4W 56K	14-5563
R5	Resistor, 1/4W 470K	14-5474
R6	Resistor, 1/4W 68K	14-5683
R8	Resistor, 1/4W 5.1K	14-5512
R9,62	Resistor, 1/4W 3.3K	14-5332
R10,13,14, 37,41-45, 60,61,80,97	Resistor, 1/4W 1K	14-5102
R12,15,16 19-22,31- 34,68,74, 75,85-88, 106	Resistor, 1/4W 3K	14-5302
R17,65	Resistor, 1/4W 240	14-5241
R18	Resistor, 1/4W 1M	14-5105
R23-30,64	Resistor, 1/4W 10K	14-5103
R35	Resistor, 1/4W 33K	14-5333
R36	Resistor, 1/4W 680	14-5681
R38	Resistor Variable (Trimpot)500K	19-411504

PARTS LIST

<u>Location</u>	<u>Description</u>	<u>Part Number</u>
R40,53,66 90,109,112 117,119,128- 131	Resistor 1/4W 100 Ohm	14-5101
R46	Resistor 1/4W 1.6K	14-5162
R47	Resistor 1/4W 36K	14-5363
R48	Resistor 1/4W 18K	14-5183
R49	Resistor 1/4W 9.1K	14-5912
R50,63,81-84 92-94	Resistor 1/4W 4.7K	14-5472
R51	Resistor 1/4W 750 Ohm	14-5751
R54	Resistor 1/4W 1.2K	14-5122
R55,56,57	Resistor 1/4W 75 Ohm	14-5750
R89	Resistor 1/4W 47K	14-5473
R76-79	Resistor 1/4W 1.8K	14-5182
R91	Resistor 1/4W 2.7K	14-5272
R95,110,118, 120-127,132 133	Resistor 1/4W 220 Ohm	14-5221
R98-105,107, 108	Resistor 1/4W 33 Ohm	14-5330
R111	Resistor 1/4W 27 Ohm	14-5270
R113,134-137	Resistor 1/4W 470 Ohm	14-5471
R114	Resistor 1/4W 1.5K	14-5152
R116	Resistor 1/4W 51 Ohm	14-5510
RN1-4	Resistor Network SIP 470 Ohm	C061668-04
S1	Switch Vertical Power (SPDT)	C061022
S2	Switch Channel Select	C019702-01
U1	IC Dual Op Amp (LM358)	C061702
U2	IC Decoder (74LS138)	C061428
U3	IC Mem Mngt Unit (MMul B)	C061618
U4	IC (16K X 8) OS ROM	C061598
U5	IC (8K X 8 ROM) Rev B	C060302
U7	IC ANTIC	C021697
U8	IC CPU (6502)	C014806
U9-16	IC (64K X 1 DRAM)	C060612
U17	IC GTIA	C014805
U18	IC AND Quad (74LS08)	C017097
U19	IC Hex Inverter (74LS14)	C061850
U20	IC Hex Buffer CMOS (CD4050B)	C010816

PARTS LIST

<u>Location</u>	<u>Description</u>	<u>Part Number</u>
U22	IC POKEY	C012294
U23	IC PIA	C014795
U24,25	IC MUX (CD4051B)	C014336
U26,27	IC Multiplexer (74LS158)	C014345
U28	IC Latch (74LS375)	C060619
U29	IC Delay Module	C060472
U30	IC AND/OR Inverter (74LS51)	C060474
W1	Resistor 1/4W 0 Ohm	C060629
XU1	Socket IC (8 pin)	C014386-01
XU18,19,30	Socket IC (14 pin)	C014386-02
XU2,9-16, 20,24-28	Socket IC (16 pin)	C014386-03
XU3	Socket IC (20 pin)	C014386-05
XU4,5	Socket IC (24 pin)	C014386-07
XU7,8,17, 22,23	Socket IC (40 pin)	C014386-09
Y1	Crystal 3.579545 MHz	C061090

SECTION 6

SERVICE BULLETINS

This section is to be used by you to file the three classifications of service bulletins that are periodically released by the Director of Technical Support.

The following are brief descriptions of each classification:

FIELD CHANGE ORDER

A Field Change Order describes mandatory hardware or software changes to ATARI products and instructs how to implement these changes. The changes must be performed on all units serviced or repaired.

UPGRADE BULLETIN

An Upgrade Bulletin describes product improvements or modifications that the consumer may wish to purchase. These bulletins allow you to modify the customer's unit to add capabilities which may not have been available when the unit was originally manufactured.

TECH TIP

A Tech Tip is a document of a general nature which transmits routine service or repair information. By communicating methods developed since you attended training classes, Tech Tips aid to continuously improve repair skills and increase knowledge of ATARI products.

Other times, Tech Tips alert you to units that have been modified and are now standard for ATARI Manufacturing, but are different from many existing units and require different repair techniques.

